

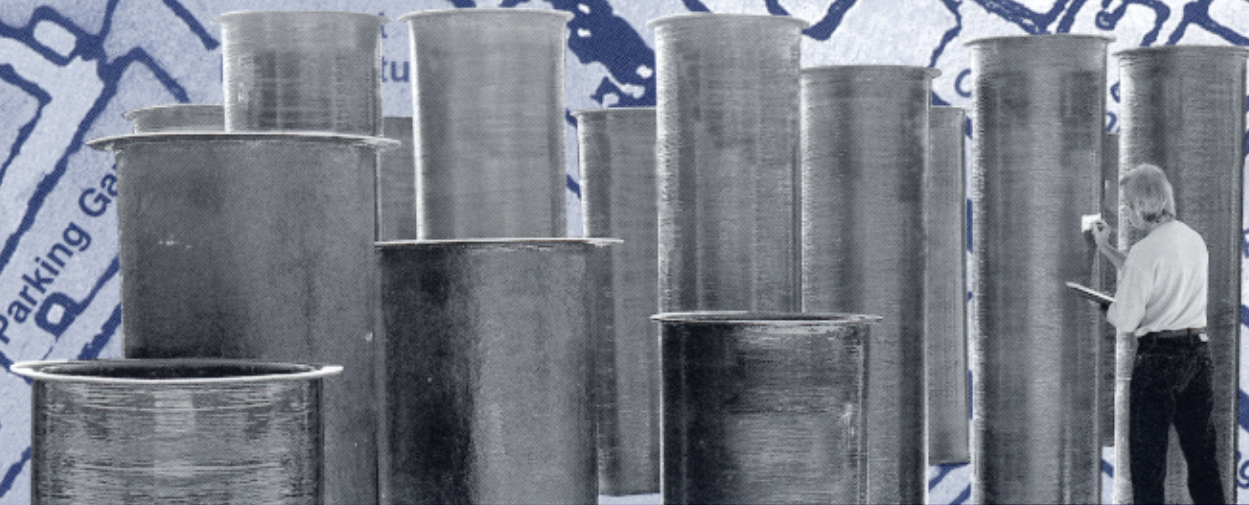

**We Are
Everywhere**

FIBERGLASS BASINS AND PACKAGED LIFT STATIONS



TOPP of the line in quality and economy!

TOPP INDUSTRIES, INC.

P.O. Box 420 • Highway 25 North • Rochester, IN 46975

Phone: 574-223-3681 • Toll Free: 800-354-4534 • Fax: 574-223-6106

www.toppindustries.com • e-mail: toppindustries@toppindustries.com

SGR Fiberglass Packaged Systems

SGR Guiderails & Accessories

Topp Industries, Inc. offers an all non-corrosive Stainless Steel Guiderail system (SGR) with a brass disconnect. SGR systems can be installed in our fiberglass basins at our facility or can be sold separately.

The SGR is constructed of 1-1/2" O.D. 304 stainless steel rails with a removable cast iron ball check valve. SGR systems can be installed in our fiberglass basins at our facility or can be sold separately.

Standard 8' rail systems consist of (2) 4' x 1-1/2" O.D. stainless steel guide rails. We offer 12", 24" & 48" extensions for applications deeper than 8'.

Topp Industries' SGR can also be made as a seamless one-piece construction available up to 20' in length. Consult factory for pricing and shipping requirements.

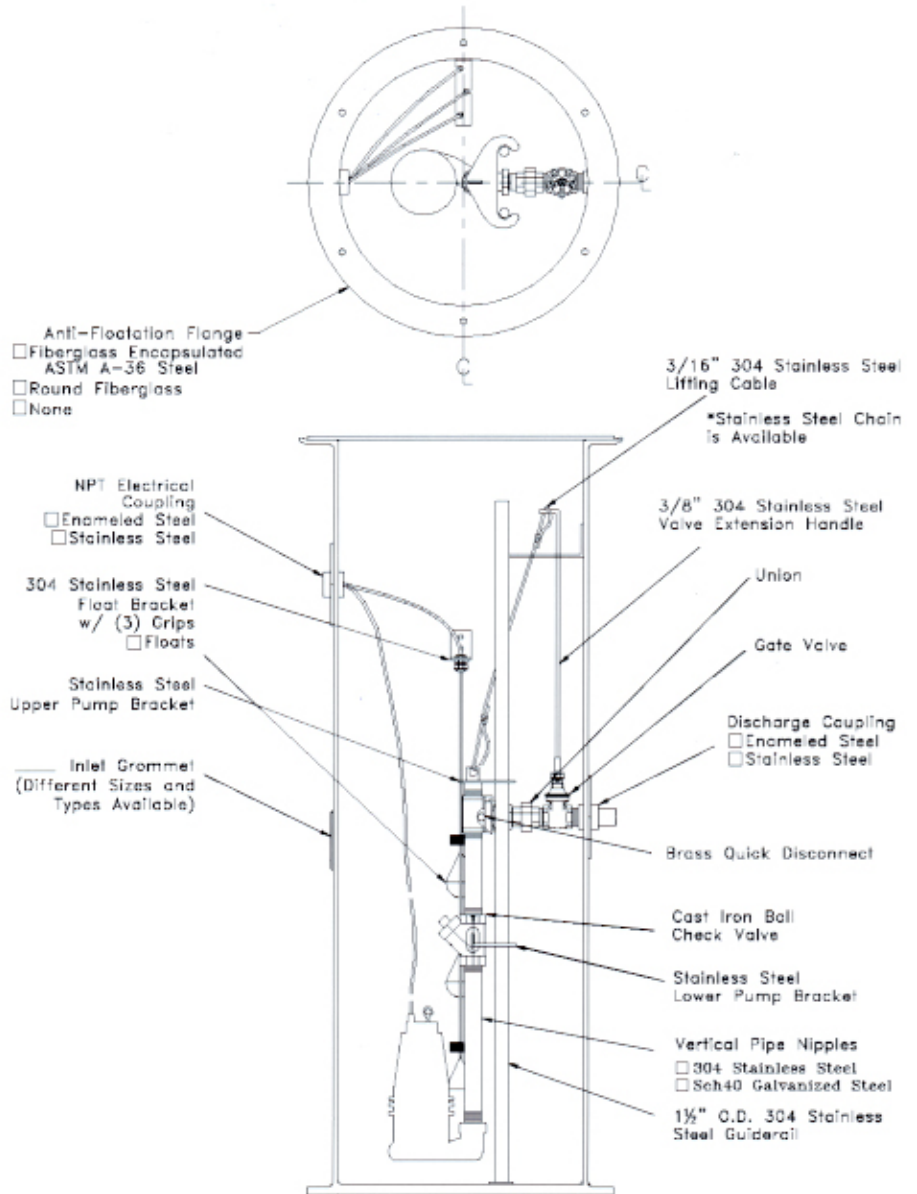

8 ft. SGR Guiderail System packaged in a 4 ft. box & Ready for UPS Shipment

1-1/2" OD x 48" Stainless Steel SGR Guiderail Extension



1-1/2" OD x 12" & 24" Stainless Steel SGR Guiderail Extensions



Galvanized or Stainless Steel Simplex Discharge Kit

Galvanized or Stainless Steel Duplex Discharge Kit



Fiberglass Basins & Accessories

Triple Garage Systems

Topp Industries, Inc. fiberglass basins are made with the highest quality material and testing standards currently in the market. Our Chop-hoop Filament wound tanks are made in 24", 30", 36" 42", 48", 60" & 72" diameters.

Basins can be made up to and beyond 20' in depth.

See website for more info.

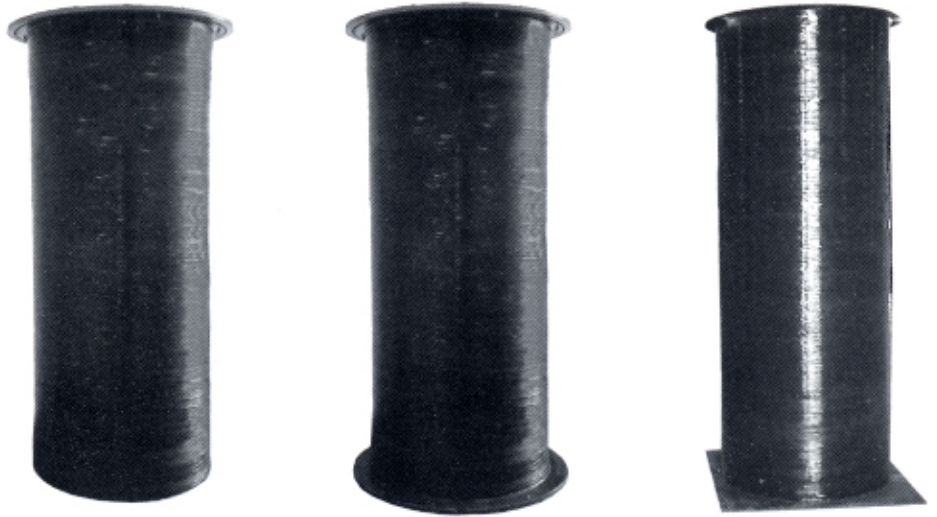

Allows volatile waste to evaporate and not get into the sewer systems. Comes in all diameters, either as a one piece construction or as three individual units for field connections. (Solid steel, gas tight cover, 4" or 6" inlets/outlets).

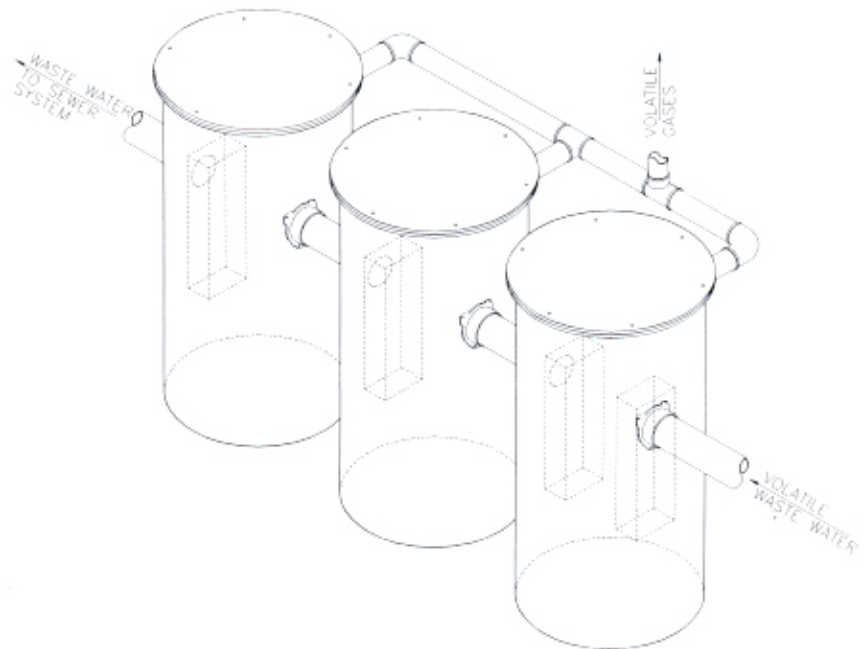

Fiberglass Extensions (available in all diameters)



Polyethylene Shipping Skid



Valve Box (various sizes available)



Fiberglass Packaged Lift Station Design

You can specify Topp Industries packaged fiberglass lift stations with confidence. Each station is designed and manufactured under a stringent quality program to meet the needs of your specific application. Topp Industries' application engineering support is available to assist you with technical considerations, product selections and lift station layout.

When your project requires a lift station, make sure you call the experts... TOPP INDUSTRIES, INC. Topp Industries has established a leadership position in the industry by providing superior quality in product, service and support.

To assist you with your projects success, Topp Industries has standard drawings and specifications available to you on CD-ROM, in AutoCAD ASCII file formats. Contact us for your copy today!

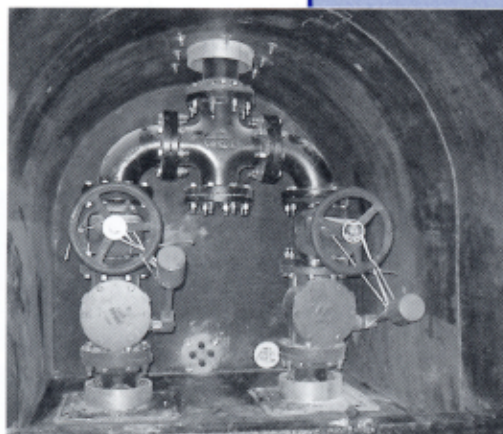
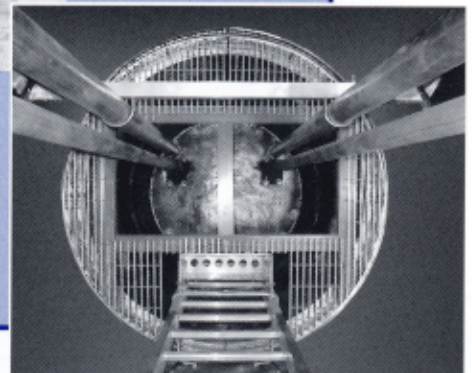
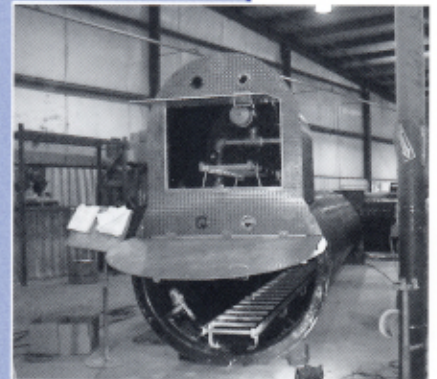

Covers & Accessories

Simplex & Duplex Junction Boxes



Simplex & Duplex Stainless Steel Float Brackets

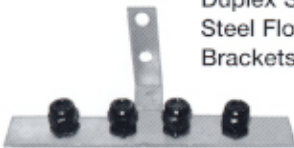

2", 3", 4" & 6" Screened Green Vent



Floats-Mechanical & Mercury



Aluminum Sleeve with Link Seals

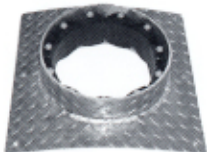

Aluminum Inlet Hubs

1"-6" Flex Boot Fittings for Straight or Angled Penetrations



Aluminum Ladder

Steel & Stainless Steel Lifting Lugs

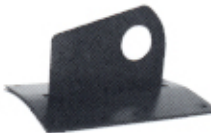

Stainless Steel & Steel Couplings



2"-8" Cast Iron Hubs

1-1/4", 1-1/2" & 2" Plastic 2-Bolt Pipe Grommet Flange



3" & 4" Cast Iron Flanges



2-Bolt Plastic Flanges, 1-1/4"-3"



1"-6" Gas-Tight Grommets



Solid Fiberglass Covers



Steel Single Hatch Door - Double Hatch Door also available

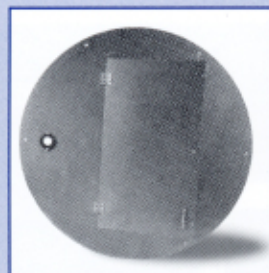

Aluminum Single Hatch Door

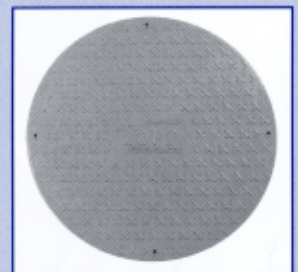

Non-Skid Solid Fiberglass Covers